

Linear

MOMO-L RGB Fixture Guide

KKDC

Indoor/Outdoor | Surface | RGB output

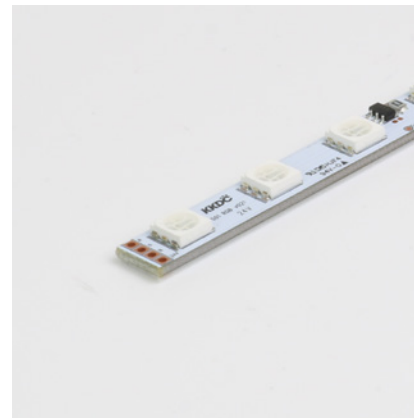

Key applications

- ✓ Architectural detail
- ✓ Backlighting & signage
- ✓ Bathrooms
- ✓ Building facades
- ✓ Direct lighting
- ✓ Exterior
- ✓ Interior
- ✓ Mirror back lighting
- ✓ Retail display
- ✓ Special effect
- ✓ Wall grazing
- ✓ Wallwashing
- ✓ Window reveal
- ✓ Wet area

Key features

- ✓ Adjustable
- ✓ Custom lengths
- ✓ Constant Voltage (CV)
- ✓ Diffusion: homogenous
- ✓ Direct view
- ✓ Glare control options
- ✓ IP44 moisture resistant
- ✓ IP67 waterproof
- ✓ LEDmix dynamic white
- ✓ Lens options
- ✓ RGB

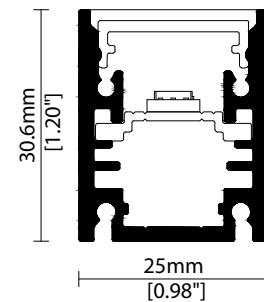

MOUNTING METHODS

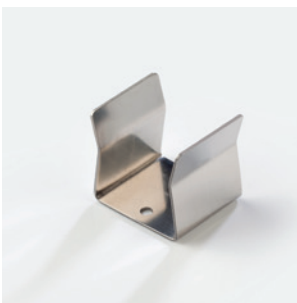

KKCP-03 Clip

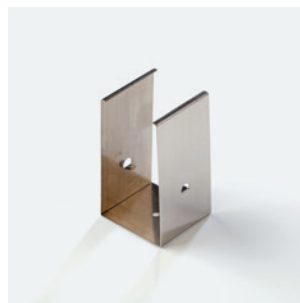

KKCP-17 Lock clip



KKBK-07 Fixing plate



KKBK-21 Adjustable bracket

Linear

MOMO-L RGB

Specification sheet



Dimensions	H30.6/W25/L103-2020mm (H1.2/W0.98/L4.05-79.52in)
PCB Cut-point	83.3mm increment/2000mm max (3.28in increment/78.74in max)
LED Pitch	13.9mm-72LED/m (0.55in - 22LED/ft)
Chip	RGB
Cover/Optics	Clear (100°)/Clear + Micro louvre/Clear + KKLN-01 lens (18°)/Clear + KKLN-01 lens (18°) + Micro louvre/ Clear + KKLN-03 lens (23°)/Clear + KKLN-03 lens (23°) + Micro louvre/Diffused (95°)
CCT	Red 620-625nm/Blue 455-460nm/Green 520-525nm
LED binning	5nm tolerance
CRI	N/A
Lifetime	50,000 hours @ 25°C (50,000 hours @ 77°F)
Operating temp	T _a = -20 to 60°C (T _c max = 70°C) T _a = -4 to 140°F (T _c max = 158°F)
IP Rating	IP44/67
Finish	Silver anodised
Mounting	Surface mounting via clips or brackets
Power feed	Sheathed hardwire tails or male/female connectors
Control	DMX/DALI



Power consumption	Supply voltage	Supply current
15.6W/m (4.75W/ft)	24V DC	0.65A/m (0.20A/ft)

Clear	Clear + Micro Louvre	Clear + 18° (KKLN-01)	Clear + 18° (KKLN-01) + Micro Louvre	Clear + 23° (KKLN-03)	Clear + 23° (KKLN-03) + Micro Louvre	Diffused Cover
Red: 125lm/m (38lm/ft) Green: 266lm/m (81lm/ft) Blue: 42lm/m (13lm/ft) RGB: 383lm/m (117lm/ft)	Red: 37lm/m (11lm/ft) Green: 77lm/m (24lm/ft) Blue: 12lm/m (4lm/ft) RGB: 111lm/m (34lm/ft)	Red: 69lm/m (21lm/ft) Green: 147lm/m (45lm/ft) Blue: 23lm/m (7lm/ft) RGB: 212lm/m (65lm/ft)	Red: 34lm/m (10lm/ft) Green: 73lm/m (22lm/ft) Blue: 11lm/m (3lm/ft) RGB: 105lm/m (32lm/ft)	Red: 70lm/m (21lm/ft) Green: 149lm/m (45lm/ft) Blue: 23lm/m (7lm/ft) RGB: 214lm/m (65lm/ft)	Red: 39lm/m (12lm/ft) Green: 84lm/m (26lm/ft) Blue: 13lm/m (4lm/ft) RGB: 120lm/m (37lm/ft)	Red: 56lm/m (17lm/ft) Green: 119lm/m (36lm/ft) Blue: 19lm/m (6lm/ft) RGB: 171lm/m (52lm/ft)

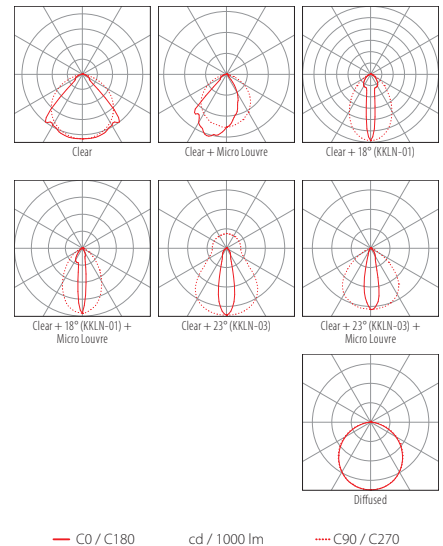
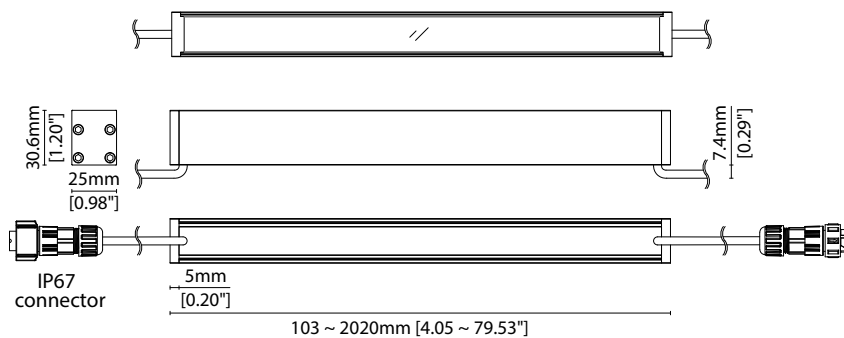

Data derived from production samples tested to UKAS/IESNA LM-79-08 standards.

See KKDÖ website for product document updates.

www.kkdc.lighting

MOMOLRGBS-03.05EN-20240517

FIXTURE

Model	Finish	Cover/Lens ¹	Grade	LED	Colour (CCT)	Length Availability ²	IP	Cable Length	Power Feed ³	Input				
MOMO-L	MO	Silver Anodised SA	B	s	501	RGB	RGB	m	103.3-2020mm 83.3mm increments	IP44 54 IP67 ⁴ 67	300mm/11.81" 0300	Single ø4.3mm sheath tail S00A	DC 24V	g
		Clear + Micro Louvre	K					i	4.07-79.53in 3.28in increments			Double ø4.3mm sheath tail D00A		
		Clear + 18° (KKLN-01)	P						(Specify length code OR total run length)			Single ø4.3mm sheath IP67 connector ⁷ S67A		
		Clear + 18° (KKLN-01) + Micro Louvre	U									Double ø4.3mm sheath IP67 connector ⁷ D67A		
		Clear + 23° (KKLN-03)	A											
		Clear + 23° (KKLN-03) + Micro Louvre	AK											
		Clear + 23° (KKLN-03) + Micro Louvre Diffused	C											

¹ Refer to **Cover/Lens Options** on **Options** pages

² Refer to **Length Availability List** or enter total run length instead of length code

³ Refer to **Power Feed Options** on **Options** pages

⁴ Due to the clear, flush potted polyurethane top layer on IP67 MOMO-L a colour shift of +/-20K should be expected

Code Example:

MO	-	SA	-	C	-	s	-	501	-	RGB	-	m	-	520	-	67	-	0300	-	D67A	-	g
MOMO-L		Silver Anodised		Diffused				501		RGB		520mm		IP67		300mm/11.81"		0300		Double ø4.3mm sheath IP67 connector		DC 24V

ACCESSORIES

Mounting Accessories

KKCP-03	Clip (1no.)
KKCP-53	Clip (500no.)
KKCP-17	Lock Clip
KKBK-07	Fixing plate
KKBK-21	Adjustable bracket

* Refer to **Mounting accessories** on **Accessories** pages

Connection Accessories

CN67-4P-0300	IP67 4 PIN RGB male & female 300mm/11.81" pair
CN67-4P-1000	IP67 4 PIN RGB male & female 1000mm/39.37" pair
CN67-4P-3000	IP67 4 PIN RGB male & female 3000mm/118.11" pair

* Refer to **Power feed** on **Accessories** pages

Exterior Junction Boxes

KKJB-07	IP67 Slim J-Box
KKJB-07R	Potting Resin for IP67 Slim J-Box

* Refer to **Exterior Junction Boxes** on **Accessories** pages

PSU/Driver

0-10V/1-10V/DALI/DMX

* Refer to **Driver/PSU Options** page for details or provide requirement and KKDC to offer the suitable option

LED ENGINE VARIANTS (LED STRIP TYPE)

Colour	LED	Lumen/m	Lumen/ft	W/m	W/ft	Spec Doc	Length	Increment
Single CCT	R007	557	170	7	2.13	MOMO-L R007	103.3-2020mm (4.05-79.52in)	41.7mm (1.64in)
	R014	1140	374	14	4.27	MOMO-L R014	103.3-2020mm (4.05-79.52in)	41.7mm (1.64in)
	R020	1615	492	20	6.10	MOMO-L R020	103.3-2020mm (4.05-79.52in)	41.7mm (1.64in)
	R030	2286	697	30	9.14	MOMO-L R030	103.3-2020mm (4.05-79.52in)	41.7mm (1.64in)
	A040	3640	1109	40	12.19	MOMO-L A040	97-1520mm (3.82-59.84in)	38.46mm (1.51in)
Warm Dim/Dynamic White	R207	1289	393	16	4.88	MOMO-L R207	103.3-2020mm (4.05-79.52in)	83.3mm (3.28in)
RGB	501	Red 125 Green 266 Blue 42 RGB 383	Red 38 Green 81 Blue 13 RGB 117	15.6	4.75	MOMO-L RGB	103.3-2020mm (4.05-79.52in)	83.3mm (3.28in)
RGBW	R201	973	297	20	6.1	MOMO-L RGBW	155-2030mm (6.10-79.92in)	62.5mm (2.46in)

* Performance data: clear cover, RGB

MOMO-L RGB

Length Availability List



Length Code		Fixture Length ¹		LED Strip ²		End Cap Dimension ³		Wattage (W)	Output (lm)
Metric	Imperial(US)	Metric	Imperial(US)	Metric	Imperial(US)	Metric	Imperial(US)		3000K (Test Data)
m0155	i0006	155mm	6.10in	125mm	4.92in	10mm	0.39in	2.50	115
m0218	i0009	218mm	8.56in	188mm	7.38in	10mm	0.39in	3.75	172
m0280	i0011	280mm	11.02in	250mm	9.84in	10mm	0.39in	5.00	230
m0343	i0013	343mm	13.48in	313mm	12.30in	10mm	0.39in	6.25	287
m0405	i0016	405mm	15.94in	375mm	14.76in	10mm	0.39in	7.50	344
m0468	i0018	468mm	18.41in	438mm	17.22in	10mm	0.39in	8.75	402
m0530	i0021	530mm	20.87in	500mm	19.69in	10mm	0.39in	10.00	459
m0593	i0023	593mm	23.33in	563mm	22.15in	10mm	0.39in	11.25	516
m0655	i0026	655mm	25.79in	625mm	24.61in	10mm	0.39in	12.50	574
m0718	i0028	718mm	28.25in	688mm	27.07in	10mm	0.39in	13.75	631
m0780	i0031	780mm	30.71in	750mm	29.53in	10mm	0.39in	15.00	689
m0843	i0033	843mm	33.17in	813mm	31.99in	10mm	0.39in	16.25	746
m0905	i0036	905mm	35.63in	875mm	34.45in	10mm	0.39in	17.50	803
m0968	i0038	968mm	38.09in	938mm	36.91in	10mm	0.39in	18.75	861
m1030	i0041	1030mm	40.55in	1000mm	39.37in	10mm	0.39in	20.00	918
m1093	i0043	1093mm	43.01in	1063mm	41.83in	10mm	0.39in	21.25	975
m1155	i0045	1155mm	45.47in	1125mm	44.29in	10mm	0.39in	22.50	1033
m1218	i0048	1218mm	47.93in	1188mm	46.75in	10mm	0.39in	23.75	1090
m1280	i0050	1280mm	50.39in	1250mm	49.21in	10mm	0.39in	25.00	1148
m1343	i0053	1343mm	52.85in	1313mm	51.67in	10mm	0.39in	26.25	1205
m1405	i0055	1405mm	55.31in	1375mm	54.13in	10mm	0.39in	27.50	1262
m1468	i0058	1468mm	57.78in	1438mm	56.59in	10mm	0.39in	28.75	1320
m1530	i0060	1530mm	60.24in	1500mm	59.06in	10mm	0.39in	30.00	1377
m1593	i0063	1593mm	62.70in	1563mm	61.52in	10mm	0.39in	31.25	1434
m1655	i0065	1655mm	65.16in	1625mm	63.98in	10mm	0.39in	32.50	1492
m1718	i0068	1718mm	67.62in	1688mm	66.44in	10mm	0.39in	33.75	1549
m1780	i0070	1780mm	70.08in	1750mm	68.90in	10mm	0.39in	35.00	1607
m1843	i0073	1843mm	72.54in	1813mm	71.36in	10mm	0.39in	36.25	1664
m1905	i0075	1905mm	75.00in	1875mm	73.82in	10mm	0.39in	37.50	1721
m1968	i0077	1968mm	77.46in	1938mm	76.28in	10mm	0.39in	38.75	1779
m2030	i0080	2030mm	79.92in	2000mm	78.74in	10mm	0.39in	40.00	1836

¹ Actual total overall length of light fixture (LED strip + end caps + void/wire hole)

² Actual length of PCB strip

³ Actual length of 2x end caps

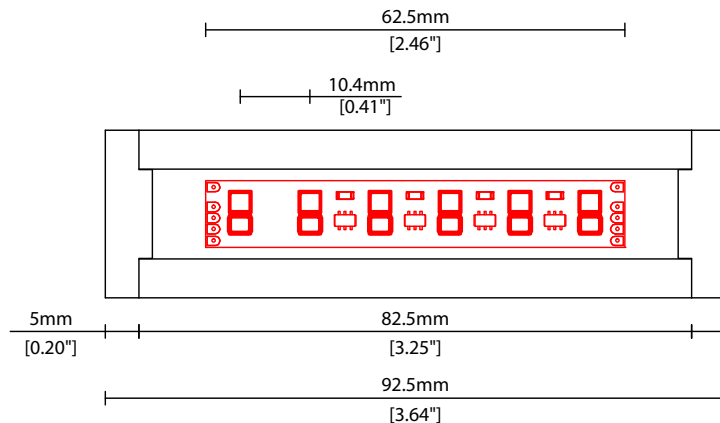

COVER/LENS OPTIONS

* Options are an integral part of the fixture ordering codes. Please refer to **Code Table** pages.

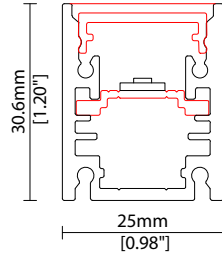

B Clear Cover
W25.0/H30.6mm (W0.98/H1.20")

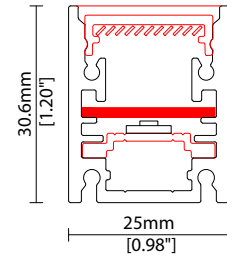

K Clear Cover + Micro Louvre
(diffused internal cover)
W25.0/H30.6mm (W0.98/H1.20")

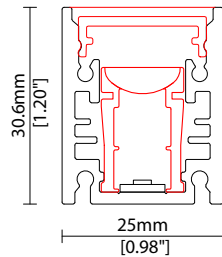

P Clear Cover + 18° (KKLN-01)
W25.0/H30.6mm (W0.98/H1.20")

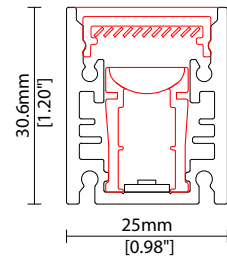
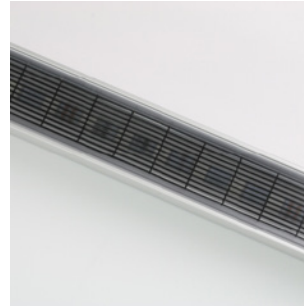

U Clear Cover + 18°
(KKLN-01) + Micro louvre
W25.0/H30.6mm (W0.98/H1.20")

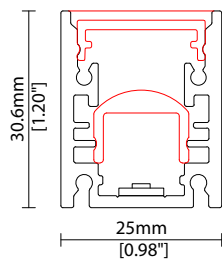
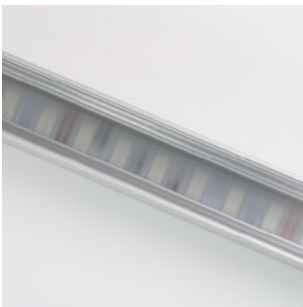

A Clear Cover + 23°
(KKLN-03) lens
W25.0/H30.6mm (W0.98/H1.20")

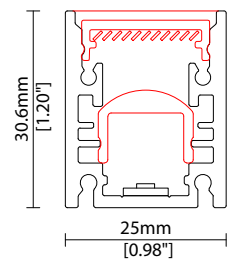
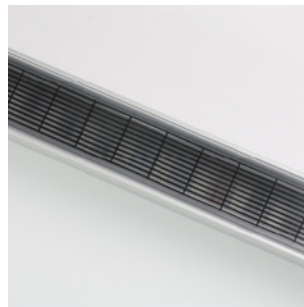

AK Clear Cover + 23° (KKLN-03)
lens + Micro Louvre
W25.0/H30.6mm (W0.98/H1.20")



MOMO-L RGB Options

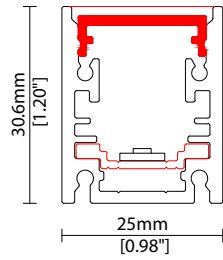

C Diffused Cover
W25.0/H30.6mm (W0.98/H1.20")

POWER FEED OPTIONS

0300 S00A 300mm (11.81") Single Ø4.3mm sheath tail

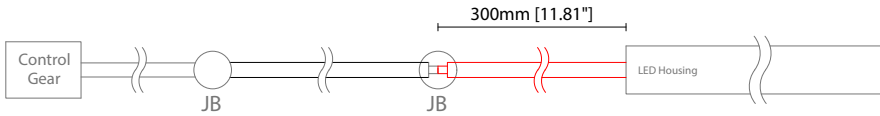

0300 D00A 300mm (11.81") Double Ø4.3mm sheath tail

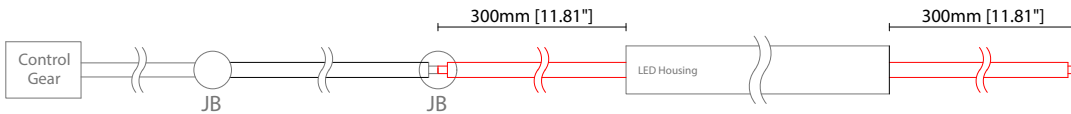

0300 S67A 300mm (11.81") Single Ø4.3mm sheath IP67 connector

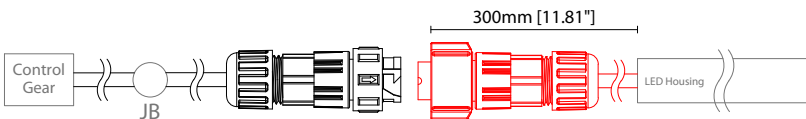

0300 D67A 300mm (11.81") Double Ø4.3mm sheath IP67 connector

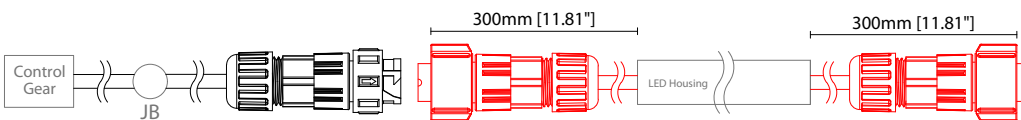

4 Pin LEDmix Female Connector IP67

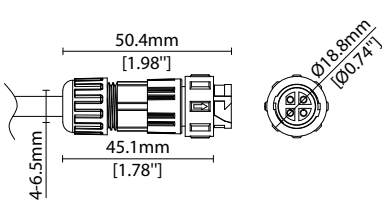

4 Pin LEDmix Male Connector IP67

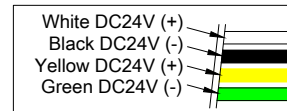
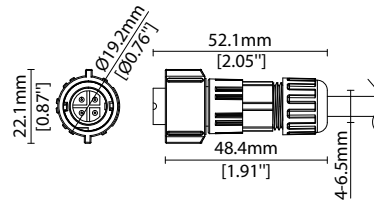

Key

Control Gear Power supply, sub-controllers & control systems

JB Junction box / cable connection

MOUNTING ACCESSORIES

Note: Accessories are to be ordered separately with corresponding code shown below.



KKCP-03 (1no.)
KKCP-53 (500no.)
 Clip (allow 3 per metre/40in)
 S/Steel finish
 L25/W33.1/H33.5mm
 (L0.98/W1.3/H1.32")

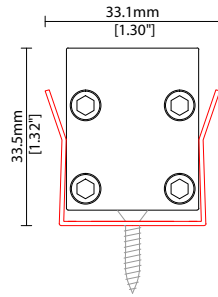

KKCP-17
 Lock clip (allow 2 per metre/40in)
 S/Steel finish
 L25/W26.1/H45mm
 (L0.98/W1.03/H1.77")

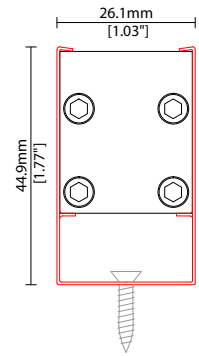

KKBK-07
 Fixing plate (allow 2 per metre/40in)
 Anodised aluminium finish
 L50/W25/H38mm
 (L1.97/W0.98/H1.5")
 Pre-assembled in factory

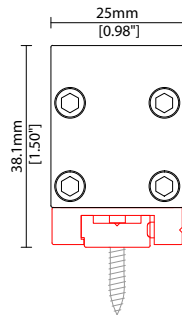

KKBK-21
 Adjustable bracket
 (allow 2 per metre/40in)
 Anodised aluminium finish
 L34/W25/H41.9mm
 (L1.34/W0.98/H1.65")
 Pre-assembled in factory

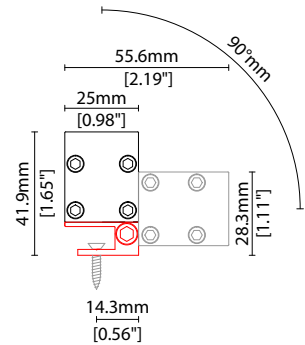

POWER FEED

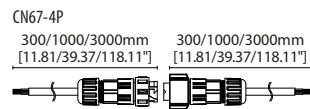

CN67-4P-0300 300mm (11.81in) pair
CN67-4P-1000 1000mm (39.37in) pair
CN67-4P-3000 3000mm (118.11in) pair

IP67

4 PIN male + female (RGB/LEDmix) connector set

EXTERIOR JUNCTION BOXES



KKJB-07

IP67 Slim J-Box
(including type A,B,C,D bushings)



KKJB-07R

Potting resin for IP67 Slim J-Box

KKDC CONTROL



KKDM-06 1-10V

visDIM dimmable sub-controller
(4 x 8A max @ 12-36V)

IP20
Plastic housing
L170/W59/H29mm
(L6.69/W2.32/H1.14in)



KKSC-05 DMX

visDIM dimmable sub-controller
(4 x 5A max @ 12-36V)

IP20
Plastic housing
L170/W53.4/H28mm
(L6.69/W2.10/H1.10in)



KKDL-02 DALI

visDIM dimmable sub-controller
(4 x 8A max @ 12-36V)

IP20
Plastic housing
L170/W59/H29mm
(L6.69/W2.32/H1.14in)



KKDL-03 DALI

visDIM dimmable sub-controller
(4 x 5A max @ 12-36V)

IP20
Plastic housing
L166/W53.4/H23mm
(L6.54/W2.10/H0.91in)

AVAILABLE PSU OPTIONS

Control Mode	PSU (Order Code)	Input Voltage AC	Output Voltage DC	Rated Output Current	Rated Power	Dim %	IP Rating
Switched	CEN-60-24	90-295V	24V	2.5A	60W	-	IP67
	HLG-60H-24	90-305V	24V	2.5A	60W	-	IP67
	HLG-100H-24	90-305V	24V	4.0A	100W	-	IP67
	HLG-150H-24	90-305V	24V	6.3A	150W	-	IP67
	HLG-240H-24	90-305V	24V	10A	240W	-	IP67
0-10V (1-10V)	PWM-40-24	90-305V	24V	1.67A	40W	100-0.15 (100-10)	IP67
	PWM-60-24	90-305V	24V	2.5A	60W	100-0.15 (100-10)	IP67
	PWM-90-24	90-305V	24V	3.67A	90W	100-0.15 (100-10)	IP67
	PWM-120-24	90-305V	24V	5.0A	120W	100-0.15 (100-10)	IP67
DALI	LIN100A1	120-277V	24V	1A per channel	100W	100-0.1	IP66/IP40
DMX RGB	LIN100A1	120-277V	24V	1.33A per channel	100W	100-0.1	IP66/IP40
DMX RGBW	LIN100A1	120-277A	24V	1A per channel	100W	100-0.1	IP66/IP40

Flicker Free Options - Combination of PSU+ sub-controller

Control Mode	PSU (Order Code)	Sub-controller (Order Code)	Input Voltage AC	Output Voltage DC	Rated Output Current	Rated Power	Dim %	IP Rating PSU/ Sub-controller
0-10V or 1-10V	CEN-60-24	KKDM-06	90-295V	24V	2.5A	60W	100-0.9	IP67/IP20
	HLG-60H-24	KKDM-06	90-295V	24V	2.5A	60W	100-0.9	IP67/IP20
	HLG-100H-24	KKDM-06	90-295V	24V	4.0A	100W	100-0.9	IP67/IP20
	HLG-150H-24	KKDM-06	90-295V	24V	6.3A	150W	100-0.9	IP67/IP20
	HLG-240H-24	KKDM-06	90-295V	24V	10.0A	240W	100-0.9	IP67/IP20
DALI	CEN-60-24	KKDL-02/03	90-295V	24V	2.5A	60W	100-0.1	IP67/IP20
	HLG-60H-24	KKDL-02/03	90-305V	24V	2.5A	60W	100-0.1	IP67/IP20
	HLG-100H-24	KKDL-02/03	90-305V	24V	4.0A	100W	100-0.1	IP67/IP20
	HLG-150H-24	KKDL-02/03	90-305V	24V	6.3A	150W	100-0.1	IP67/IP20
	HLG-240H-24	KKDL-02/03	90-305V	24V	10.0A	240W	100-0.1	IP67/IP20
DMX RGB	CEN-60-24	KKSC-05	90-295V	24V	2.5A	60W	100-0.9	IP67/IP20
	HLG-60H-24	KKSC-05	90-305V	24V	2.5A	60W	100-0.9	IP67/IP20
	HLG-100H-24	KKSC-05	90-305V	24V	4A	100W	100-0.9	IP67/IP20
	HLG-150H-24	KKSC-05	90-305V	24V	6.3A	150W	100-0.9	IP67/IP20
	HLG-240H-24	KKSC-05	90-305V	24V	10.0A	240W	100-0.9	IP67/IP20

¹ The items shown above cover the most frequently used specification but does not exhaust the possible options

² PSU and/or driver can be chosen from the table, or KKDC may recommend the best option upon receipt of the controls requirement and installation environment

³ Electrical shop drawing will include detailed information of PSU and relevant control drivers

⁴ Cut sheets are available on the controls section of www.kkdc.lighting or upon request